

产品规格书

纪春华	朴致均	赵宇辉	郑羿
2018. 11. 16	2018. 11. 16	2018. 11. 16	2018. 11. 16

规格书更改履历:

序号	更改内容	履历号	更改时间	责任人
1	新规制定	000	2018. 11. 16	郑羿



Descriptions

- General purpose amplifier
- High voltage application

Features

- High collector breakdown voltage
: $V_{CEO} = 120V$
- Low collector saturation voltage
: $V_{CE(sat)} = 0.5V(MAX.)$

PIN Connection

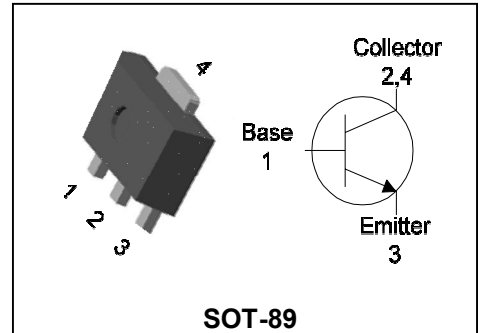

Ordering Information

Type No.	Marking	Package Code
KTC4073F	M73 □YMD.	SOT-89

M73: DEVICE CODE, □ : h_{FE} rank, YMD(Y : Year code, M :Month , D:Day . Dalian)

Absolute maximum ratings

($T_a = 25^\circ C$)

Characteristic	Symbol	Ratings	Unit
Collector-Base voltage	V_{CBO}	120	V
Collector-Emitter voltage	V_{CEO}	120	V
Emitter-Base voltage	V_{EBO}	6	V
Collector current	I_C	1	A(DC)
	I_{CP}^*	2	A(Pulse)
Collector power dissipation	P_C	0.5	W
	P_C^{**}	1	
Junction temperature	T_J	150	$^\circ C$
Storage temperature	T_{stg}	-55~150	$^\circ C$

Characteristic		Symbol	Typ.	Max	Unit
Thermal resistance	Junction-ambient	$R_{th(J-A)}$	-	250.0	$^\circ C/W$
		$R_{th(J-A)}^{**}$	-	125.0	

* : Single pulse, $t_p = 300 \mu s$

** : When mounted on ceramic substrate($250 \text{ mm}^2 \times 0.8 \text{ t}$)

Electrical Characteristics**(Ta=25°C)**

Characteristic	Symbol	Test Condition	Min.	Typ.	Max.	Unit
Collector-Base breakdown voltage	BV_{CBO}	$I_C=100\mu A, I_E=0$	120	-	-	V
Collector-Emitter breakdown voltage	BV_{CEO}	$I_C=1mA, I_B=0$	120	-	-	V
Emitter-Base breakdown voltage	BV_{EBO}	$I_E=100\mu A, I_C=0$	6	-	-	V
Collector cut-off current	I_{CBO}	$V_{CB}=120V, I_E=0$	-	-	0.1	μA
Emitter cut-off current	I_{EBO}	$V_{EB}=4V, I_C=0$	-	-	0.1	μA
DC current gain	$h_{FE}^{1)}$	$V_{CE}=5V, I_C=30mA$	200	-	400	-
Collector-Emitter saturation voltage	$V_{CE(sat)}^{2)}$	$I_C=500mA, I_B=50mA$	-	-	0.5	V
		$I_C=100mA, I_B=10mA$	-	-	0.1	V
		$I_C=120mA, I_B=2mA$	-	-	0.15	V
		$I_C=200mA, I_B=2mA$	-	-	0.3	V
Base-Emitter turn on voltage	$V_{BE(on)}^{2)}$	$V_{CE}=0.2V, I_C=200mA$	0.6	-	0.85	V
Base-Emitter saturation voltage	$V_{BE(sat)}^{2)}$	$I_C=500mA, I_B=50mA$	-	-	1.2	V
Transition frequency	f_T	$V_{CE}=5V, I_C=50mA$	-	170	-	MHz
Collector output capacitance	C_{ob}	$V_{CB}=10V, I_E=0, f=1MHz$	-	10	-	pF

* Note 1) hFE Rank : 200~400 only

* Note 2) Pulse Tester : Pulse Width $\leq 300\mu s$, Duty Cycle $\leq 2.0\%$

Electrical Characteristic Curves

Fig. 1 $P_C - T_a$

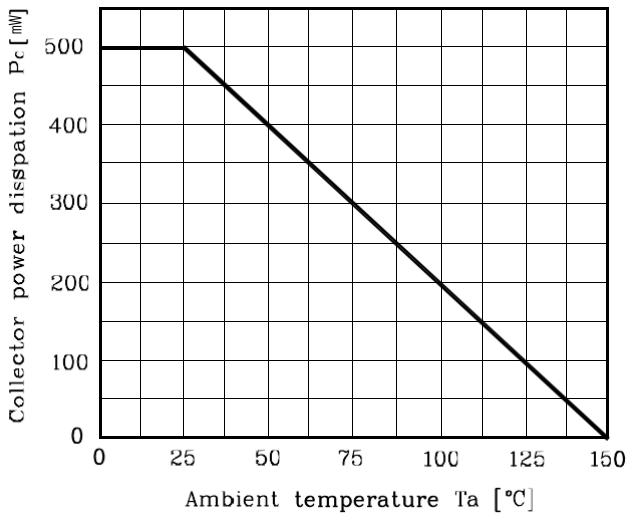

Fig. 2 $I_C - V_{BE}$

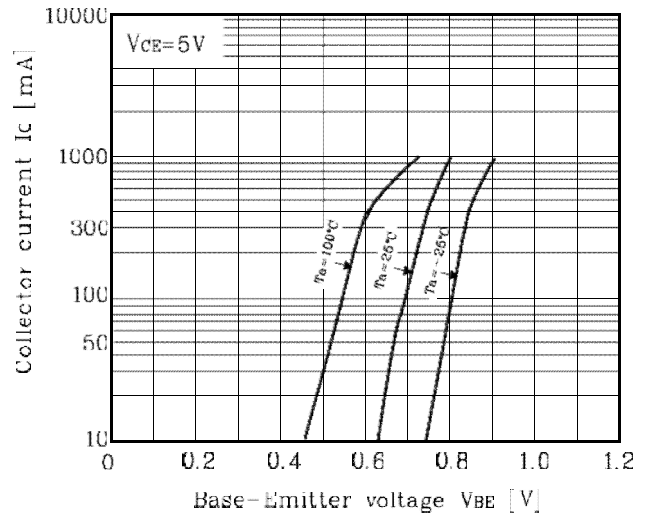

Fig. 3 $V_{CE(sat)} - I_C$

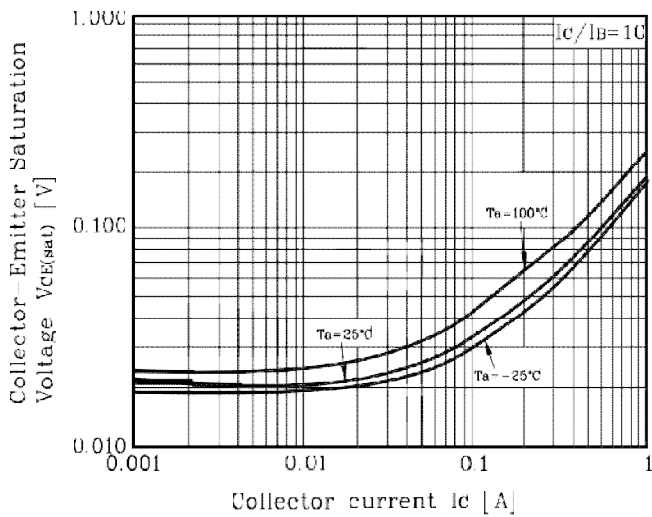

Fig. 4 $I_C - V_{CE}$

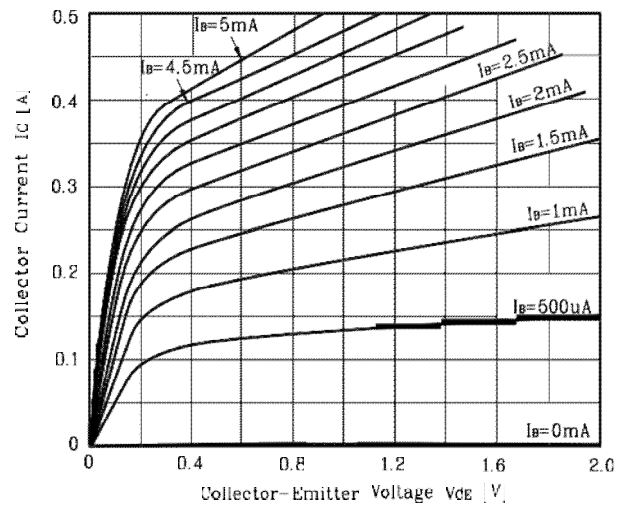

Fig. 5 $I_C - V_{CE}$

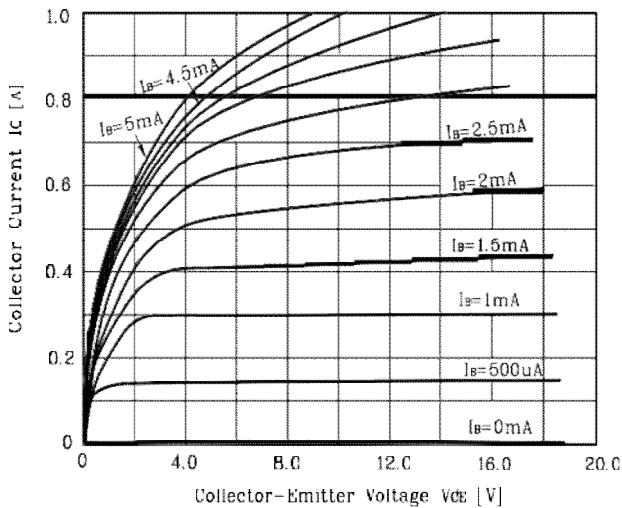
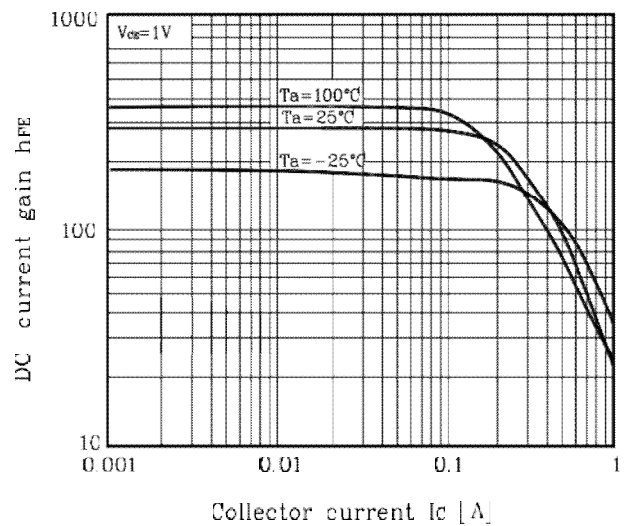

Fig. 6 $h_{FE} - I_C$



Electrical Characteristic Curves

Fig. 7 $h_{FE}-I_C$

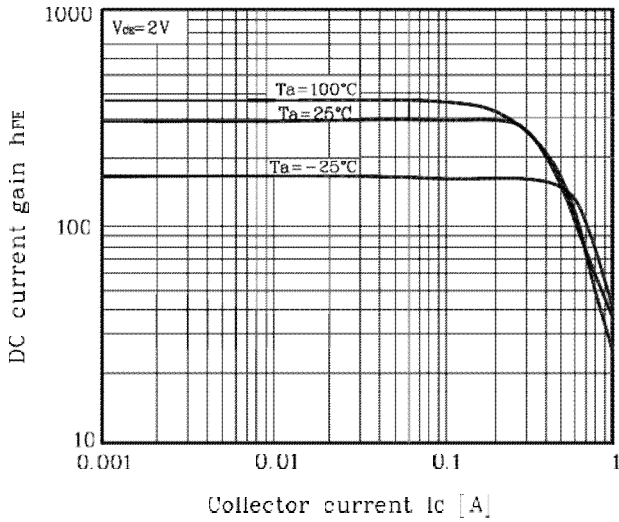

Fig. 8 $h_{FE}-I_C$

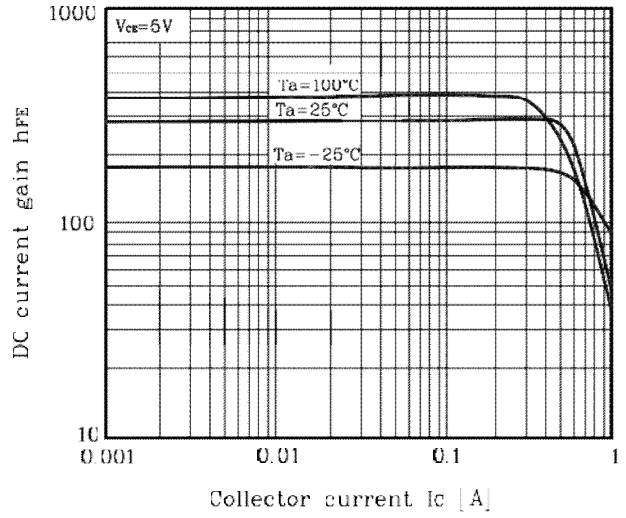

Fig. 9 $h_{FE}-I_C$

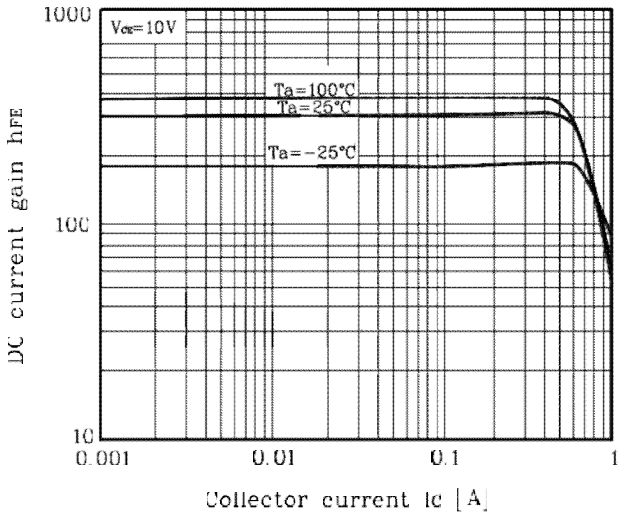

Fig. 10 $C_{ob} - V_{CB}$

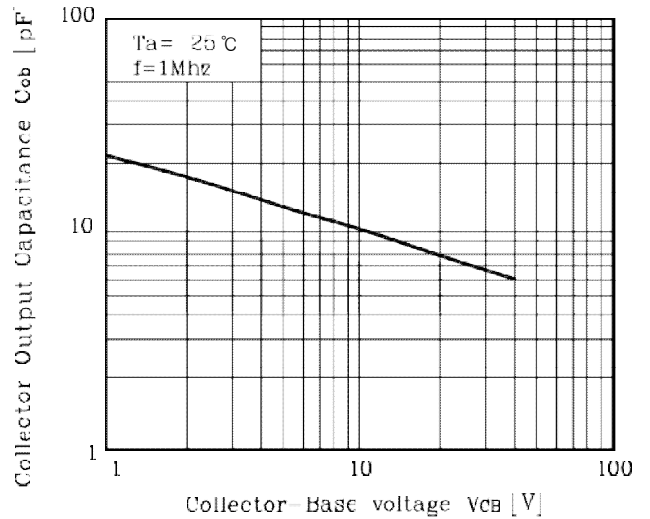

Fig. 11 $f_T - I_C$

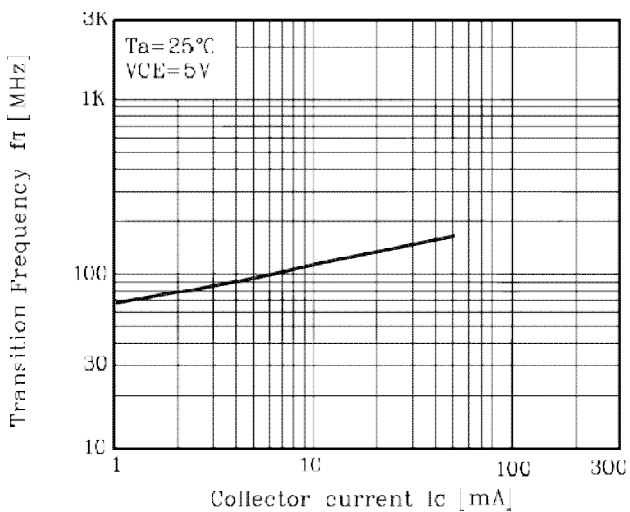
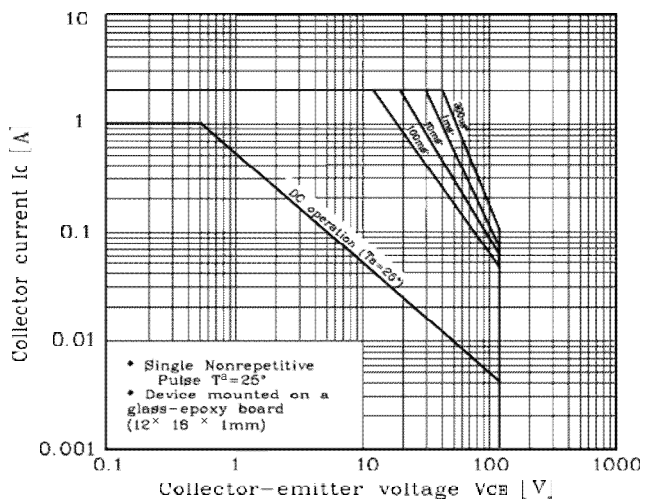
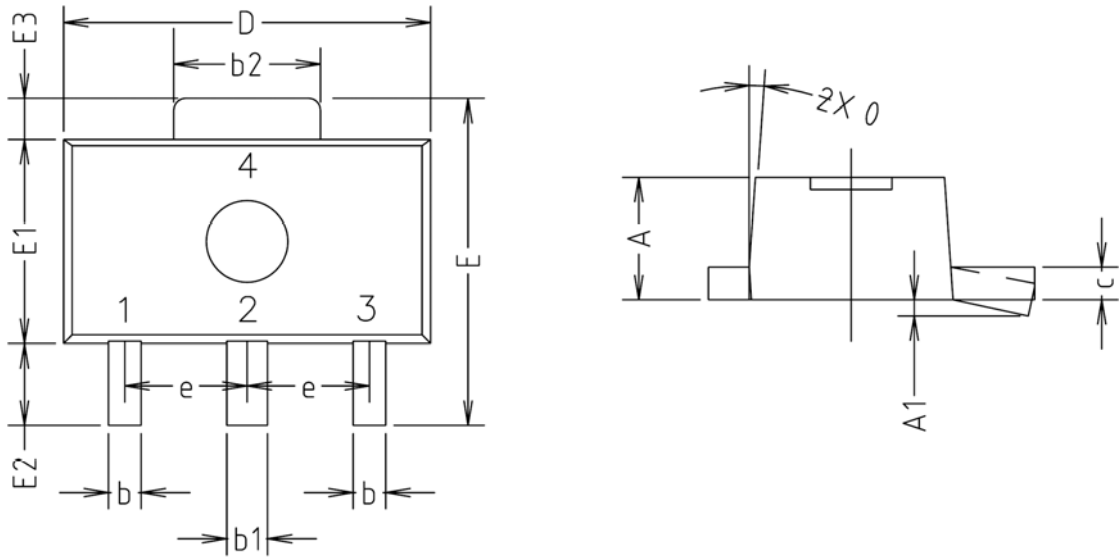

Fig. 12 Safe operating Area



Outline Dimension(mm)



SYMBOL	MILLIMETERS			NOTE
	MINIMUM	NOMINAL	MAXIMUM	
A	1.40	1.50	1.60	
A1	0.00	—	0.10	
b	0.38	0.42	0.48	
b1	0.48	0.52	0.58	
b2	1.79	1.82	1.87	
c	0.40	0.42	0.46	
D	4.40	4.50	4.70	
E	3.70	4.00	4.30	
E1	2.40	2.50	2.70	
E2	0.80	1.00	1.20	
E3	0.40	0.50	0.60	
e	1.50 TYP.			
θ	4° TYP.			

※Recommend PCB solder land [Unit: mm]

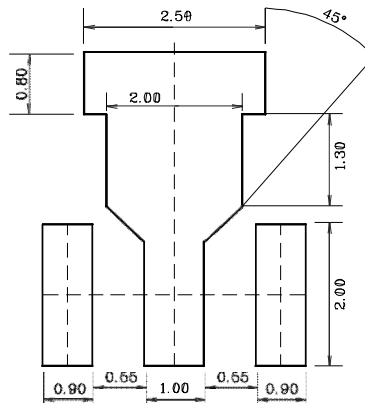

The AUK Dalian Corp. products are intended for the use as components in general electronic equipment (Office and communication equipment, measuring equipment, home appliance, etc.).

Please make sure that you consult with us before you use these AUK Dalian Corp. products in equipments which require high quality and / or reliability, and in equipments which could have major impact to the welfare of human life(atomic energy control, airplane, spaceship, transportation, combustion control, all types of safety device, etc.). AUK Dalian Corp. cannot accept liability to any damage which may occur in case these AUK Dalian Corp. products were used in the mentioned equipments without prior consultation with AUK Dalian Corp..

Specifications mentioned in this publication are subject to change without notice.